

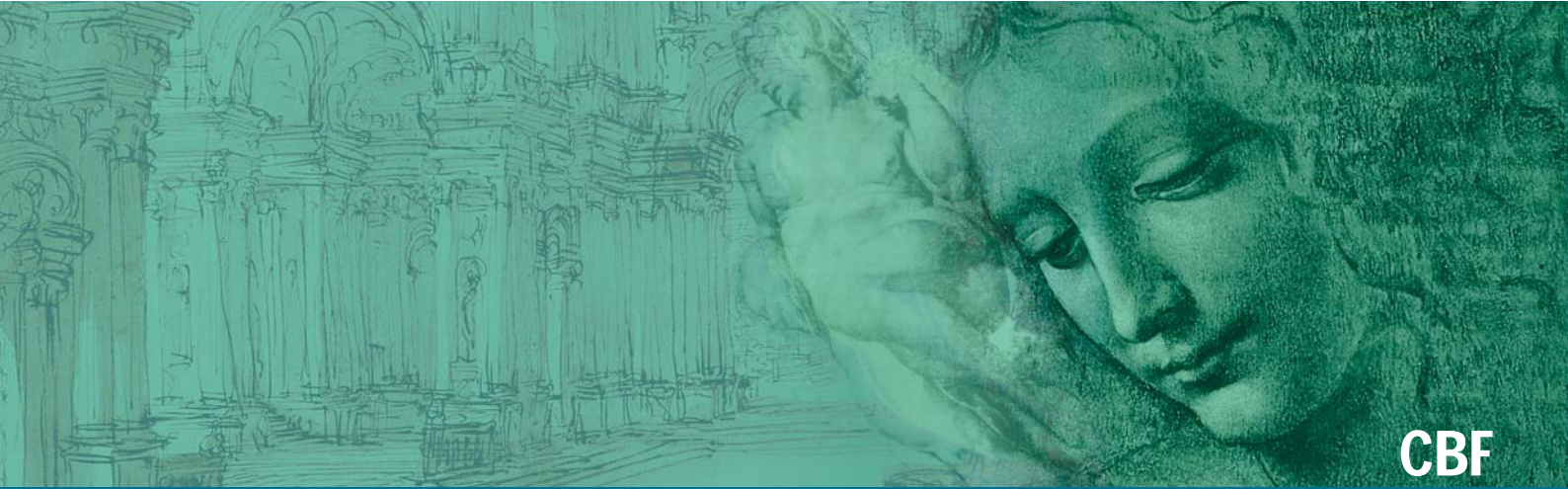

GREEN ELECTRONICS



CBF

Terminal Blocks and Connectors for Printed Circuit Boards



ISO
9001



ISO
14001



BS OHSAS
18001:2007



SAURO[®]
ELECTRONIC CONNECTORS
— by the law —

Distributed by:



www.texim-europe.com

Functional characteristics**Dimensional class:**

low

**Standard colour:**

green

**Dimensions:**
 11.65 x 20.75 mm
 (.459 x .817 in)
**Max approved wire size:**
 solid: 1.5 mm² (IEC EN); 14 AWG (UL)
 stranded: 1.5 mm² (IEC EN); 14 AWG (UL)
wire entry size:

2.4 x 1.95 mm (.094 x .076 in)

**Versions:**
 side stackable,
 locking screw flanges
**Single mould poles:**
 from 2 to 25 (side stackable)
 from 2 to 23 (locking screw flanges)
**Pitches:**
 metric 3.5 mm, 7 mm
 (.138 in, .276 in)

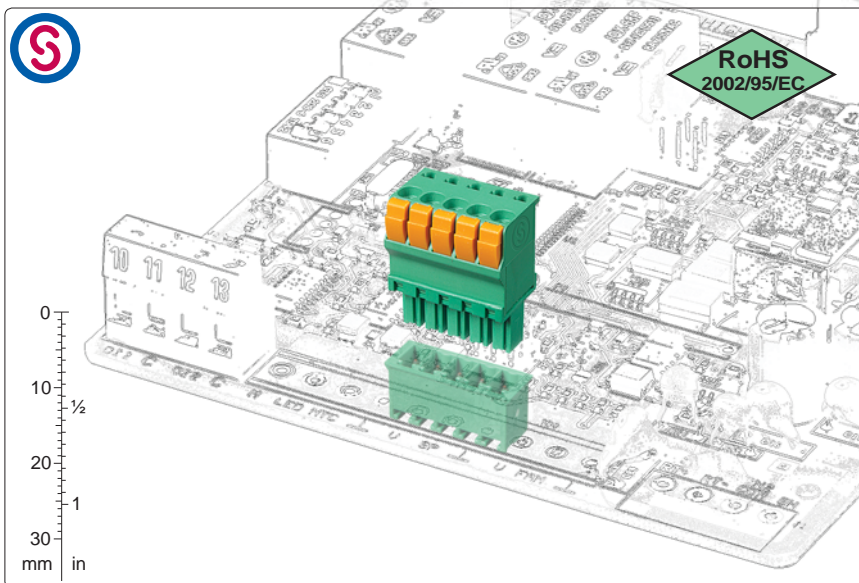
 imperial 3.81 mm, 7.62 mm
 (.150 in, .300 in)
RoHS
2002/95/EC
 pitch 3.5/3.81 mm
 from 2 to 25 poles
 side stackable, right

 CKF-SC1
 coding splines
Brief description

Although the **CBF** female connector series is small in size it offers a high number of connection possibilities; in fact it can wire up to 1.5mm² (14AWG) and therefore a current range of 11A can be reached.

It is available in 3.5 mm (.138 in), and 7 mm (.275 in) metric pitches and in 3.81 mm (.100 in), and 7.62 mm (.300 in) Imperial pitches, in monolithic housings from 2 to 25 poles, in side-stackable version.

The **CBF** Connector Series for PCBs features an asymmetric profile, so mistakes are prevented when connections are made with the corresponding CTM male connector which is soldered to the board. Further safety when connecting can be obtained by using the CTM-LC1

and CKF-SC1 coding splines and coding clips.

The basic connectors can be stacked to obtain any number of poles without losing the pitch. By taking advantage of this particular feature a minimum quantity of basic connectors can be stored.

It is simple to manage products, warehouse and assembly in Kit packages because several versions can be obtained with only one code, both the part-numbers and the risk of making mistakes being significantly reduced.

Distributed by:



Components features

Steel clamping spring

Polyamide housing

Standard colour: green
V0 self-extinguishing according to UL 94.
Chlorinated solvents resistant,
with no phosphor, dioxin or
detrimental to health halogens.

Lead-free tin-plated copper alloy spring

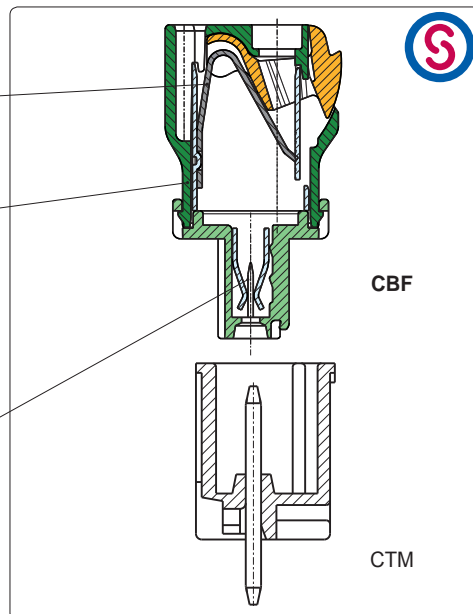

Mechanical features

Insertion force per pole	max 3 N (max .674 lbf)
Withdrawal force per pole	min 1,5 N (min .337 lbf)
Stripping length	9 ÷ 10 mm (.41 ÷ .45 in)
Operating temperature range	-40 °C ÷ +110 °C (-40 °F ÷ +230 °F)
Climatic category	40/110/21 according to EN 60068-1

Electrical features*

Solid wire section	0.14 ÷ 1.5 mm ² (IEC EN)* 30÷14 AWG (UL)*
Stranded wire section	0.14 ÷ 1.5 mm ² (IEC EN)* 30÷14 AWG (UL)*
Rated voltage for 3.5 mm (.138 in) and 3.81 mm (.150 in) pitch	300 V (UL)*
Rated voltage for 7 mm (.276 in) and 7.62 mm (.300 in) pitch	750 V (IEC EN)*
Rated current	11 A (UL)*
Contact resistance	<15 mΩ
Insulation resistance	>10 ⁹ Ω (500V DC)

*All the a.m. data refer to the highest values amongst the certified ones.

V voltage, I current values and tightening torque are related to the norms to be applied to the product and to its use.

Approvals

IEC-EN	IEC:	130 V - T 110 - 8 A - 1.5 mm ² solid and stranded for 3.5 mm and 3.81 mm pitch
	EN 61984	750 V - T 110 - 8 A - 1.5 mm ² solid and stranded for 7 mm and 7.62 mm pitch
UL	UL:	300 V - 11 A - 30÷14 AWG stranded for 3.5 mm, 3.81 mm, 7 mm and 7.62 mm pitch
	file E167473	Application values for end-use equipment have to be in accordance to UL norms and applicable to them.
VDE	VDE:	130 V - 8 A - T 110 - 1.5 mm ² for 3.5 mm and 3.81 mm pitch
	pending	450 V - 8 A - T 110 - 1.5 mm ² for 7 mm and 7.62 mm pitch
IMQ	IMQ:	130 V - T 110 - 8 A - 1.5 mm ² solid and stranded for 3.5 mm and 3.81 mm pitch
	pending	750 V - T 110 - 8 A - 1.5 mm ² solid and stranded for 7 mm and 7.62 mm pitch

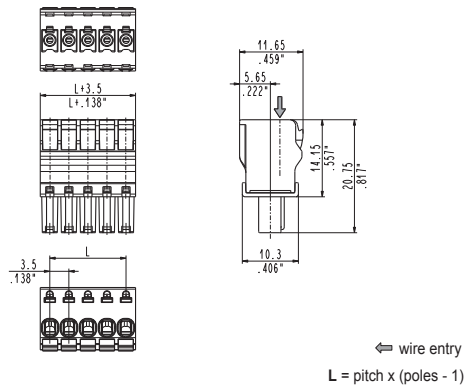

⇐ wire entry

L = pitch x (poles - 1)

CBF_0R8 right side stackable female

3.5 mm / .138" pitch

Poles	Code	Pcs/pack.	W [kg]*	Pcs/Ind.**	W [kg]*
02	CBF020R8	500	0,78	2000	3,12
03	CBF030R8	400	0,94	1750	4,10
04	CBF040R8	300	0,94	1500	4,68
05	CBF050R8	250	0,98	1500	5,85
06	CBF060R8	200	0,94	1250	5,85
07	CBF070R8	175	0,96	1250	6,83
08	CBF080R8	125	0,78	1000	6,24
09	CBF090R8	125	0,88	1000	7,02
10	CBF100R8	100	0,78	1000	7,80
11	CBF110R8	100	0,86	750	6,44
12	CBF120R8	75	0,70	750	7,02
13	CBF130R8	75	0,76	750	7,61
14	CBF140R8	100	1,09	750	8,19
15	CBF150R8	100	1,17	750	8,78
16	CBF160R8	100	1,25	750	9,36
17	CBF170R8	50	0,66	500	6,63
18	CBF180R8	50	0,70	500	7,02
19	CBF190R8	50	0,74	500	7,41
20	CBF200R8	50	0,78	500	7,80
21	CBF210R8	50	0,82	500	8,19
22	CBF220R8	50	0,86	500	8,58
23	CBF230R8	50	0,90	250	4,49
24	CBF240R8	50	0,94	250	4,68
25	CBF250R8	50	0,98	250	4,88

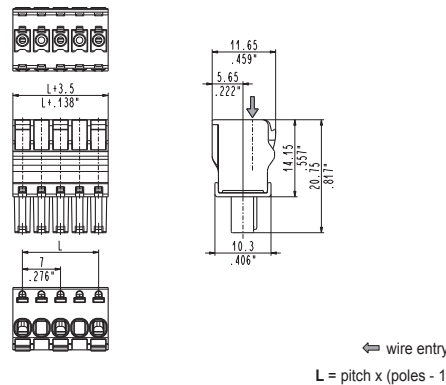

⇐ wire entry

L = pitch x (poles - 1)

CBF_0R9 right side stackable female

7 mm / .276" pitch

Poles	Code	Pcs/pack.	W [kg]*	Pcs/Ind.**	W [kg]*
02	CBF020R9	400	0,86	1750	3,78
03	CBF030R9	250	0,81	1500	4,86
04	CBF040R9	175	0,76	1250	5,40
05	CBF050R9	125	0,68	1000	5,40
06	CBF060R9	100	0,65	750	4,86
07	CBF070R9	100	0,76	750	5,67
08	CBF080R9	100	0,86	750	6,48
09	CBF090R9	50	0,49	500	4,86
10	CBF100R9	50	0,54	500	5,40
11	CBF110R9	50	0,59	500	5,94
12	CBF120R9	50	0,65	250	3,24
13	CBF130R9	50	0,70	250	3,51

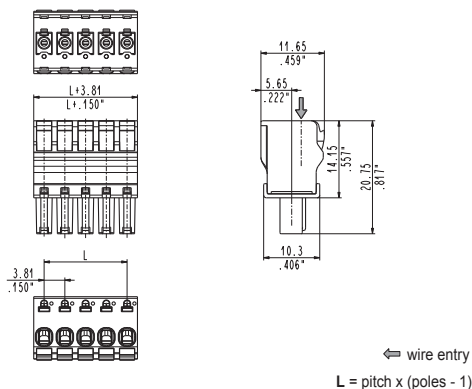

⇐ wire entry

L = pitch x (poles - 1)

CBF_0RT right side stackable female

3.81 mm / .150" pitch

Poles	Code	Pcs/pack.	W [kg]*	Pcs/Ind.**	W [kg]*
02	CBF020RT	500	0,85	2000	3,40
03	CBF030RT	400	1,02	1750	4,46
04	CBF040RT	300	1,02	1500	5,10
05	CBF050RT	250	1,06	1500	6,38
06	CBF060RT	200	1,02	1250	6,38
07	CBF070RT	175	1,04	1250	7,44
08	CBF080RT	125	0,85	1000	6,80
09	CBF090RT	125	0,96	1000	7,65
10	CBF100RT	100	0,85	1000	8,50
11	CBF110RT	100	0,94	750	7,01
12	CBF120RT	75	0,77	750	7,65
13	CBF130RT	75	0,83	750	8,29
14	CBF140RT	100	1,19	750	8,93
15	CBF150RT	100	1,28	750	9,56
16	CBF160RT	100	1,36	750	10,20
17	CBF170RT	50	0,72	500	7,23
18	CBF180RT	50	0,77	500	7,65
19	CBF190RT	50	0,81	500	8,08
20	CBF200RT	50	0,85	500	8,50
21	CBF210RT	50	0,89	500	8,93
22	CBF220RT	50	0,94	500	9,35
23	CBF230RT	50	0,98	250	4,89
24	CBF240RT	50	1,02	250	5,10
25	CBF250RT	50	1,06	250	5,31

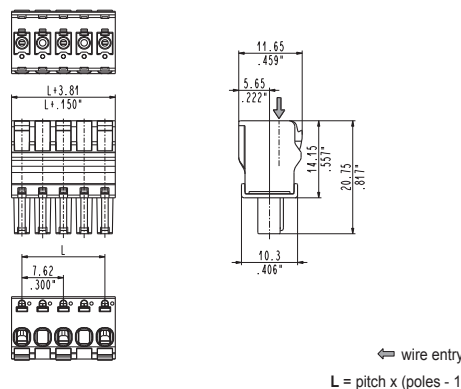

⇐ wire entry

L = pitch x (poles - 1)

CBF_0R7 right side stackable female

7.62 mm / .300" pitch

Poles	Code	Pcs/pack.	W [kg]*	Pcs/Ind.**	W [kg]*
02	CBF020R7	400	0,86	1750	3,78
03	CBF030R7	250	0,81	1500	4,86
04	CBF040R7	175	0,76	1250	5,40
05	CBF050R7	125	0,68	1000	5,40
06	CBF060R7	100	0,65	750	4,86
07	CBF070R7	100	0,76	750	5,67
08	CBF080R7	100	0,86	750	6,48
09	CBF090R7	50	0,49	500	4,86
10	CBF100R7	50	0,54	500	5,40
11	CBF110R7	50	0,59	500	5,94
12	CBF120R7	50	0,65	250	3,24
13	CBF130R7	50	0,70	250	3,51

Distributed by:



www.texim-europe.com

*W [kg]: approximate weight per box in kg

**Industrial packaging: add "-00000E" at standard code

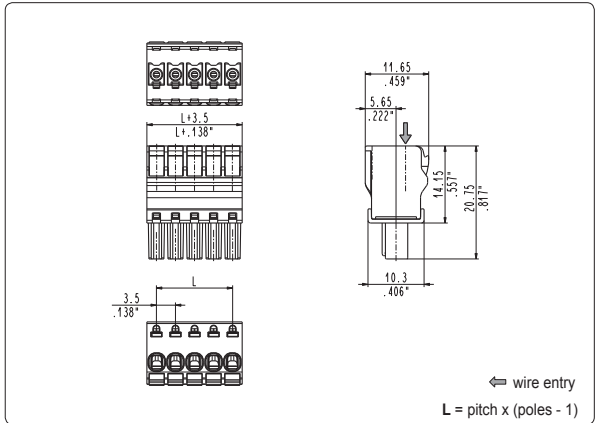

CBF_0L8 left side stackable female

3.5 mm / .138" pitch

Poles	Code	Pcs/pack.	W [kg]*	Pcs/Ind.**	W [kg]*
02	CBF020L8	500	0,78	2000	3,12
03	CBF030L8	400	0,94	1750	4,10
04	CBF040L8	300	0,94	1500	4,68
05	CBF050L8	250	0,98	1500	5,85
06	CBF060L8	200	0,94	1250	5,85
07	CBF070L8	175	0,96	1250	6,83
08	CBF080L8	125	0,78	1000	6,24
09	CBF090L8	125	0,88	1000	7,02
10	CBF100L8	100	0,78	1000	7,80
11	CBF110L8	100	0,86	750	6,44
12	CBF120L8	75	0,70	750	7,02
13	CBF130L8	75	0,76	750	7,61
14	CBF140L8	100	1,09	750	8,19
15	CBF150L8	100	1,17	750	8,78
16	CBF160L8	100	1,25	750	9,36
17	CBF170L8	50	0,66	500	6,63
18	CBF180L8	50	0,70	500	7,02
19	CBF190L8	50	0,74	500	7,41
20	CBF200L8	50	0,78	500	7,80
21	CBF210L8	50	0,82	500	8,19
22	CBF220L8	50	0,86	500	8,58
23	CBF230L8	50	0,90	250	4,49
24	CBF240L8	50	0,94	250	4,68
25	CBF250L8	50	0,98	250	4,88

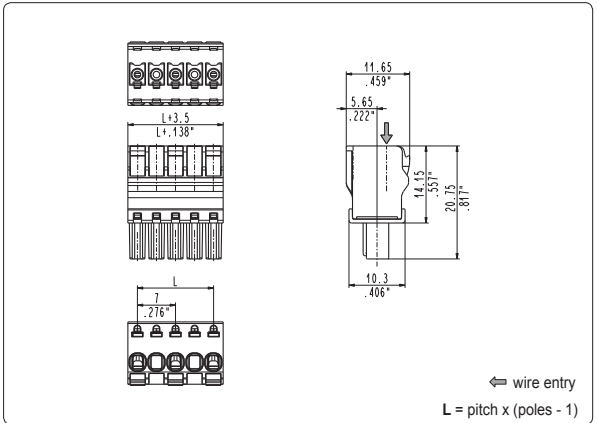

CBF_0L9 left side stackable female

7 mm / .276" pitch

Poles	Code	Pcs/pack.	W [kg]*	Pcs/Ind.**	W [kg]*
02	CBF020L9	400	0,86	1750	3,78
03	CBF030L9	250	0,81	1500	4,86
04	CBF040L9	175	0,76	1250	5,40
05	CBF050L9	125	0,68	1000	5,40
06	CBF060L9	100	0,65	750	4,86
07	CBF070L9	100	0,76	750	5,67
08	CBF080L9	100	0,86	750	6,48
09	CBF090L9	50	0,49	500	4,86
10	CBF100L9	50	0,54	500	5,40
11	CBF110L9	50	0,59	500	5,94
12	CBF120L9	50	0,65	250	3,24
13	CBF130L9	50	0,70	250	3,51

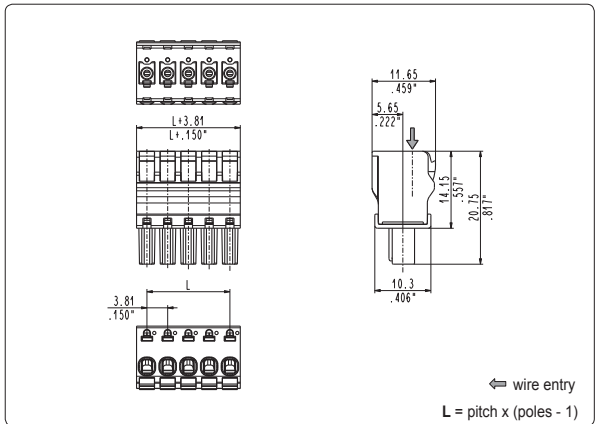

CBF_0LT left side stackable female

3.81 mm / .150" pitch

Poles	Code	Pcs/pack.	W [kg]*	Pcs/Ind.**	W [kg]*
02	CBF020LT	500	0,85	2000	3,40
03	CBF030LT	400	1,02	1750	4,46
04	CBF040LT	300	1,02	1500	5,10
05	CBF050LT	250	1,06	1500	6,38
06	CBF060LT	200	1,02	1250	6,38
07	CBF070LT	175	1,04	1250	7,44
08	CBF080LT	125	0,85	1000	6,80
09	CBF090LT	125	0,96	1000	7,65
10	CBF100LT	100	0,85	1000	8,50
11	CBF110LT	100	0,94	750	7,01
12	CBF120LT	75	0,77	750	7,65
13	CBF130LT	75	0,83	750	8,29
14	CBF140LT	100	1,19	750	8,93
15	CBF150LT	100	1,28	750	9,56
16	CBF160LT	100	1,36	750	10,20
17	CBF170LT	50	0,72	500	7,23
18	CBF180LT	50	0,77	500	7,65
19	CBF190LT	50	0,81	500	8,08
20	CBF200LT	50	0,85	500	8,50
21	CBF210LT	50	0,89	500	8,93
22	CBF220LT	50	0,94	500	9,35
23	CBF230LT	50	0,98	250	4,89
24	CBF240LT	50	1,02	250	5,10
25	CBF250LT	50	1,06	250	5,31

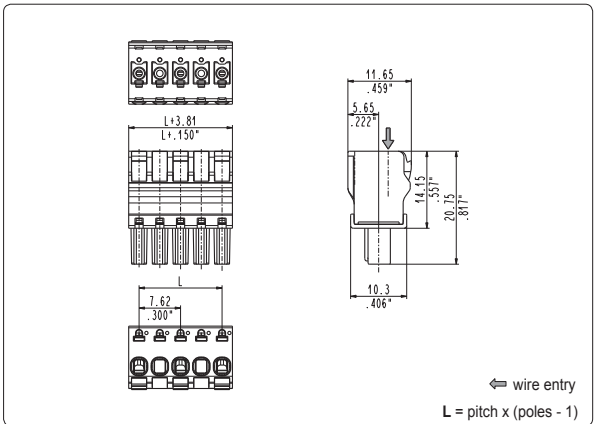

CBF_0L7 left side stackable female

7.62 mm / .300" pitch

Poles	Code	Pcs/pack.	W [kg]*	Pcs/Ind.**	W [kg]*
02	CBF020L7	400	0,86	1750	3,78
03	CBF030L7	250	0,81	1500	4,86
04	CBF040L7	175	0,76	1250	5,40
05	CBF050L7	125	0,68	1000	5,40
06	CBF060L7	100	0,65	750	4,86
07	CBF070L7	100	0,76	750	5,67
08	CBF080L7	100	0,86	750	6,48
09	CBF090L7	50	0,49	500	4,86
10	CBF100L7	50	0,54	500	5,40
11	CBF110L7	50	0,59	500	5,94
12	CBF120L7	50	0,65	250	3,24
13	CBF130L7	50	0,70	250	3,51

Distributed by:

www.texim-europe.com

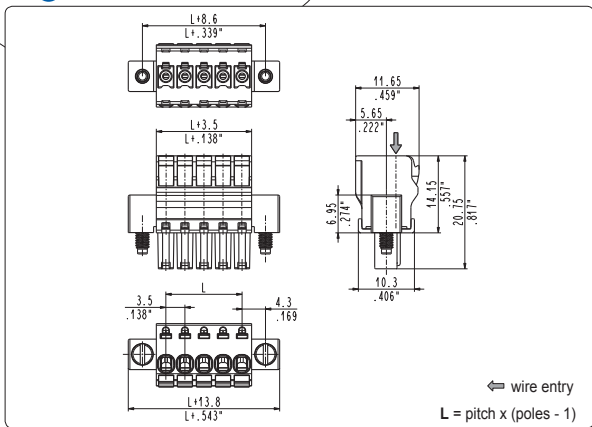

CBF_0D8 right locking screw flanges female

3.5 mm / .138" pitch

Poles	Code	Pcs/pack.	W [kg]*	Pcs/Ind.**	W [kg]*
02	CBF020D8	250	0,59	1250	2,95
03	CBF030D8	200	0,63	1000	3,14
04	CBF040D8	175	0,69	1000	3,92
05	CBF050D8	150	0,71	750	3,53
06	CBF060D8	125	0,69	750	4,11
07	CBF070D8	100	0,63	500	3,13
08	CBF080D8	100	0,70	500	3,52
09	CBF090D8	75	0,59	500	3,91
10	CBF100D8	75	0,65	500	4,30
11	CBF110D8	75	0,70	500	4,69
12	CBF120D8	75	0,76	500	5,08
13	CBF130D8	75	0,82	250	2,74
14	CBF140D8	50	0,59	250	2,93
15	CBF150D8	50	0,63	250	3,13
16	CBF160D8	50	0,66	250	3,32
17	CBF170D8	50	0,70	250	3,52
18	CBF180D8	50	0,74	250	3,71
19	CBF190D8	50	0,78	250	3,91
20	CBF200D8	50	0,82	250	4,10
21	CBF210D8	50	0,86	250	4,30
22	CBF220D8	50	0,90	250	4,49
23	CBF230D8	50	0,94	250	4,69

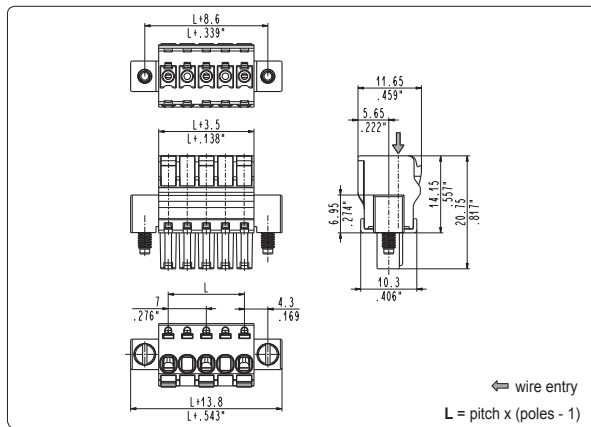

CBF_0D9 right locking screw flanges female

7 mm / .276" pitch

Poles	Code	Pcs/pack.	W [kg]*	Pcs/Ind.**	W [kg]*
02	CBF020D9	200	0,59	1000	2,96
03	CBF030D9	150	0,61	750	3,03
04	CBF040D9	100	0,51	500	2,56
05	CBF050D9	75	0,47	500	3,10
06	CBF060D9	75	0,55	500	3,64
07	CBF070D9	75	0,63	250	2,09
08	CBF080D9	50	0,47	250	2,36
09	CBF090D9	50	0,53	250	2,63
10	CBF100D9	50	0,58	250	2,90
11	CBF110D9	50	0,63	250	3,17
12	CBF120D9	50	0,69	250	3,44

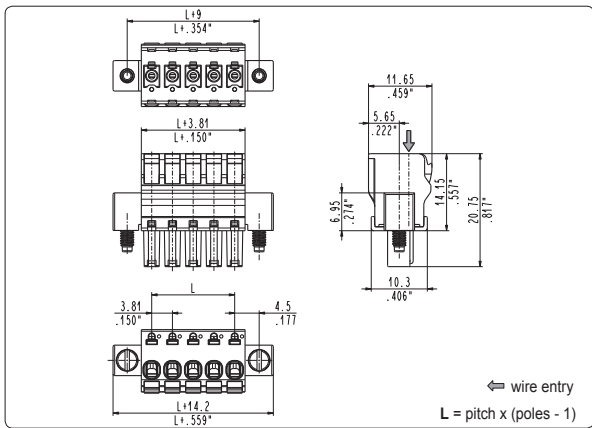

CBF_0DT right locking screw flanges female

3.81 mm / .150" pitch

Poles	Code	Pcs/pack.	W [kg]*	Pcs/Ind.**	W [kg]*
02	CBF020DT	250	0,59	1250	2,95
03	CBF030DT	200	0,63	1000	3,14
04	CBF040DT	175	0,69	1000	3,92
05	CBF050DT	150	0,71	750	3,53
06	CBF060DT	125	0,69	750	4,11
07	CBF070DT	100	0,63	500	3,13
08	CBF080DT	100	0,70	500	3,52
09	CBF090DT	75	0,59	500	3,91
10	CBF100DT	75	0,65	500	4,30
11	CBF110DT	75	0,70	500	4,69
12	CBF120DT	75	0,76	500	5,08
13	CBF130DT	75	0,82	250	2,74
14	CBF140DT	50	0,59	250	2,93
15	CBF150DT	50	0,63	250	3,13
16	CBF160DT	50	0,66	250	3,32
17	CBF170DT	50	0,70	250	3,52
18	CBF180DT	50	0,74	250	3,71
19	CBF190DT	50	0,78	250	3,91
20	CBF200DT	50	0,82	250	4,10
21	CBF210DT	50	0,86	250	4,30
22	CBF220DT	50	0,90	250	4,49
23	CBF230DT	50	0,94	250	4,69

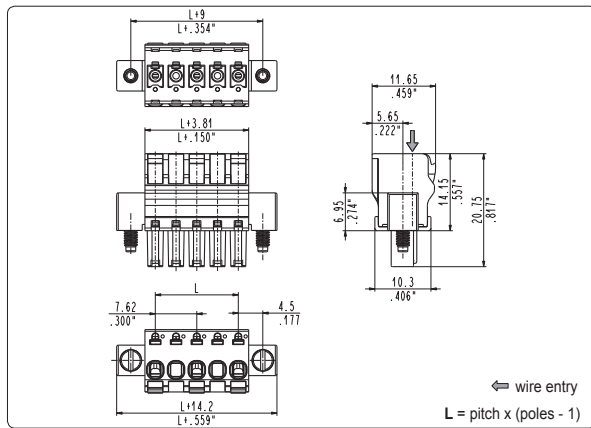

CBF_0D7 right locking screw flanges female

7.62 mm / .300" pitch

Poles	Code	Pcs/pack.	W [kg]*	Pcs/Ind.**	W [kg]*
02	CBF020D7	200	0,59	1000	2,96
03	CBF030D7	150	0,61	750	3,03
04	CBF040D7	100	0,51	500	2,56
05	CBF050D7	75	0,47	500	3,10
06	CBF060D7	75	0,55	500	3,64
07	CBF070D7	75	0,63	250	2,09
08	CBF080D7	50	0,47	250	2,36
09	CBF090D7	50	0,53	250	2,63
10	CBF100D7	50	0,58	250	2,90
11	CBF110D7	50	0,63	250	3,17
12	CBF120D7	50	0,69	250	3,44

Distributed by:

www.texim-europe.com

*W [kg]: approximate weight per box in kg

**Industrial packaging: add "-00000E" at standard code

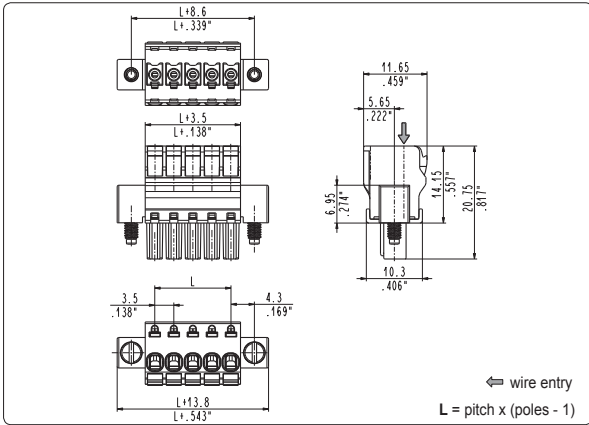

CBF_0S8 left locking screw flanges female

3.5 mm / .138" pitch

Poles	Code	Pcs/pack.	W [kg]*	Pcs/Ind.**	W [kg]*
02	CBF020S8	250	0,59	1250	2,95
03	CBF030S8	200	0,63	1000	3,14
04	CBF040S8	175	0,69	1000	3,92
05	CBF050S8	150	0,71	750	3,53
06	CBF060S8	125	0,69	750	4,11
07	CBF070S8	100	0,63	500	3,13
08	CBF080S8	100	0,70	500	3,52
09	CBF090S8	75	0,59	500	3,91
10	CBF100S8	75	0,65	500	4,30
11	CBF110S8	75	0,70	500	4,69
12	CBF120S8	75	0,76	500	5,08
13	CBF130S8	75	0,82	250	2,74
14	CBF140S8	50	0,59	250	2,93
15	CBF150S8	50	0,63	250	3,13
16	CBF160S8	50	0,66	250	3,32
17	CBF170S8	50	0,70	250	3,52
18	CBF180S8	50	0,74	250	3,71
19	CBF190S8	50	0,78	250	3,91
20	CBF200S8	50	0,82	250	4,10
21	CBF210S8	50	0,86	250	4,30
22	CBF220S8	50	0,90	250	4,49
23	CBF230S8	50	0,94	250	4,69

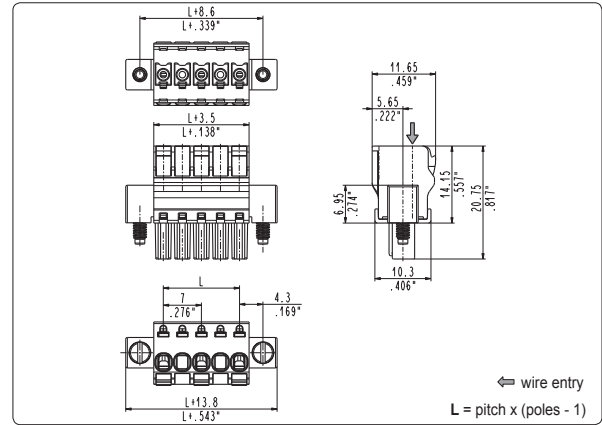

CBF_0S9 left locking screw flanges female

7 mm / .276" pitch

Poles	Code	Pcs/pack.	W [kg]*	Pcs/Ind.**	W [kg]*
02	CBF020S9	200	0,59	1000	2,96
03	CBF030S9	150	0,61	750	3,03
04	CBF040S9	100	0,51	500	2,56
05	CBF050S9	75	0,47	500	3,10
06	CBF060S9	75	0,55	500	3,64
07	CBF070S9	75	0,63	250	2,09
08	CBF080S9	50	0,47	250	2,36
09	CBF090S9	50	0,53	250	2,63
10	CBF100S9	50	0,58	250	2,90
11	CBF110S9	50	0,63	250	3,17
12	CBF120S9	50	0,69	250	3,44

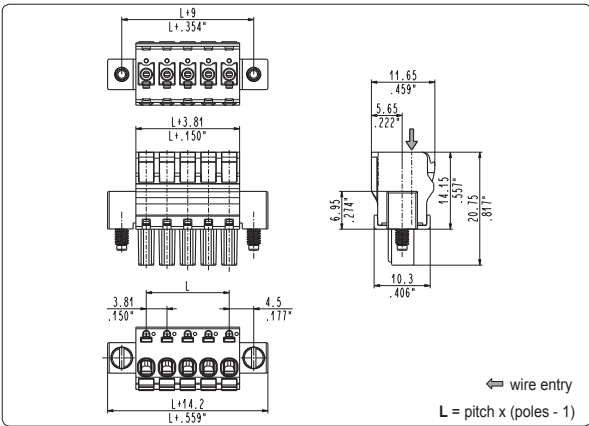

CBF_0ST left locking screw flanges female

3.81 mm / .150" pitch

Poles	Code	Pcs/pack.	W [kg]*	Pcs/Ind.**	W [kg]*
02	CBF020ST	250	0,59	1250	2,95
03	CBF030ST	200	0,63	1000	3,14
04	CBF040ST	175	0,69	1000	3,92
05	CBF050ST	150	0,71	750	3,53
06	CBF060ST	125	0,69	750	4,11
07	CBF070ST	100	0,63	500	3,13
08	CBF080ST	100	0,70	500	3,52
09	CBF090ST	75	0,59	500	3,91
10	CBF100ST	75	0,65	500	4,30
11	CBF110ST	75	0,70	500	4,69
12	CBF120ST	75	0,76	500	5,08
13	CBF130ST	75	0,82	250	2,74
14	CBF140ST	50	0,59	250	2,93
15	CBF150ST	50	0,63	250	3,13
16	CBF160ST	50	0,66	250	3,32
17	CBF170ST	50	0,70	250	3,52
18	CBF180ST	50	0,74	250	3,71
19	CBF190ST	50	0,78	250	3,91
20	CBF200ST	50	0,82	250	4,10
21	CBF210ST	50	0,86	250	4,30
22	CBF220ST	50	0,90	250	4,49
23	CBF230ST	50	0,94	250	4,69

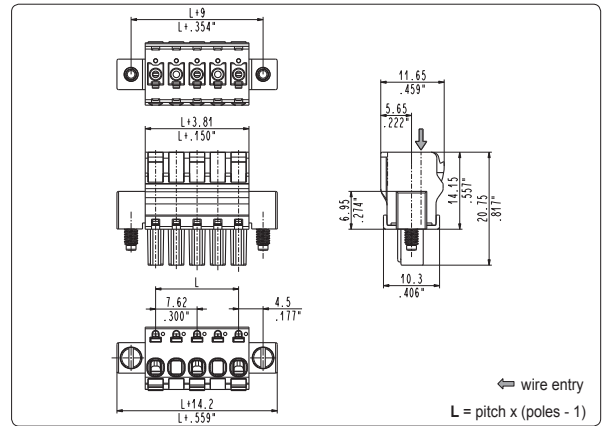

CBF_0S7 left locking screw flanges female

7.62 mm / .300" pitch

Poles	Code	Pcs/pack.	W [kg]*	Pcs/Ind.**	W [kg]*
02	CBF020S7	200	0,59	1000	2,96
03	CBF030S7	150	0,61	750	3,03
04	CBF040S7	100	0,51	500	2,56
05	CBF050S7	75	0,47	500	3,10
06	CBF060S7	75	0,55	500	3,64
07	CBF070S7	75	0,63	250	2,09
08	CBF080S7	50	0,47	250	2,36
09	CBF090S7	50	0,53	250	2,63
10	CBF100S7	50	0,58	250	2,90
11	CBF110S7	50	0,63	250	3,17
12	CBF120S7	50	0,69	250	3,44

Distributed by:

www.texim-europe.com

TEXIM EUROPE

Partner in Electronic Components & Supply Chain Solutions



The Netherlands

Elektrostraat 17
NL-7483 PG Haaksbergen
Tel: +31 (0)53 573 33 33
Fax: +31 (0)53 573 33 30
nl@texim-europe.com



Denmark

Nørregade 15
DK-9240 Nibe
Tel: +45 88 20 26 30
Fax: +45 88 20 26 39
nordic@texim-europe.com



Belgium

Gentsesteenweg 1154-C22
Chaussée de Gand 1154-C22
B-1082 Brussel / Bruxelles
Tel: +32 (0)2 462 01 00
Fax: +32 (0)2 462 01 25
belgium@texim-europe.com



United Kingdom

St. Mary's House, Church Lane
Carlton Le Moorland
Lincoln LN5 9HS
Tel: +44 (0)1522 789 555
Fax: +44 (0)845 299 22 26
uk@texim-europe.com



Germany

Justus-von-Liebig-Ring 7-9
D-25451 Quickborn
Tel: +49 (0)4106 627 07-0
Fax: +49 (0)4106 627 07-20
germany@texim-europe.com



Germany

Martin-Kollar-Strasse 9
D-81829 München
Tel: +49 (0)89 436 086-0
Fax: +49 (0)89 436 086-19
germany@texim-europe.com



Austria

Warwitzstrasse 9
A-5020 Salzburg
Tel: +43 (0)662 216026
Fax: +43 (0)662 216026-66
austria@texim-europe.com

Texim Europe B.V.

Elektrostraat 17
NL-7483 PG Haaksbergen
Tel: +31 (0)53 573 33 33
info@texim-europe.com
www.texim-europe.com

